

## Drop-In Drop-in bain-marie, with one well (2 GN container capacity)

ITEM # \_\_\_\_\_

MODEL # \_\_\_\_\_

NAME # \_\_\_\_\_

SIS # \_\_\_\_\_

AIA # \_\_\_\_\_



341000 (D01H2)

\* NOT TRANSLATED \*

### Main Features

- Electronic overheating protection.
- Designed to serve the food in gastronorm containers.
- Suitable for GN 1/1 containers with a maximum height of 200 mm.
- Automatic water refill guarantees constant heating performances and prevent unit breakage.
- Precise temperature control and setting at 0,1°C .
- As standard the product comes with digitally controlled thermostat which is in line of HACCP norms and provides visual alarm as a warning of the increasing or decreasing temperatures.
- Designed to work with both hot and cold inlet water.
- It is possible to transform one of the GNs to soup dispenser with the available accessory.
- CB and CE certified by a third party notified body.
- Designed to be positioned in flush installation providing improved cleanliness and suitable for modern design installations.
- Available drop-in dimensions: 2, 3, 4, 5, 6 GN.
- Food introduced at the correct temperature maintains its core temperature according to Afnor Standards.

### Construction

- Heating elements connected to the well bottom include safety thermostat
- Well bottom is inclined to facilitate water drainage.
- IPX4 water resistance certification.
- Well in 304 AISI stainless steel with rounded corners to facilitate cleaning operations. The well is also equipped with a drain hole.
- Electronic control with temperature display.

### Sustainability

- Etched foil heating elements to maximize heat transmission for reduced warm-up times.
- 19mm thick rock wool isolated with galvanize sheet guarantees excellent well insulation to reduce energy dispersion.



APPROVAL: \_\_\_\_\_

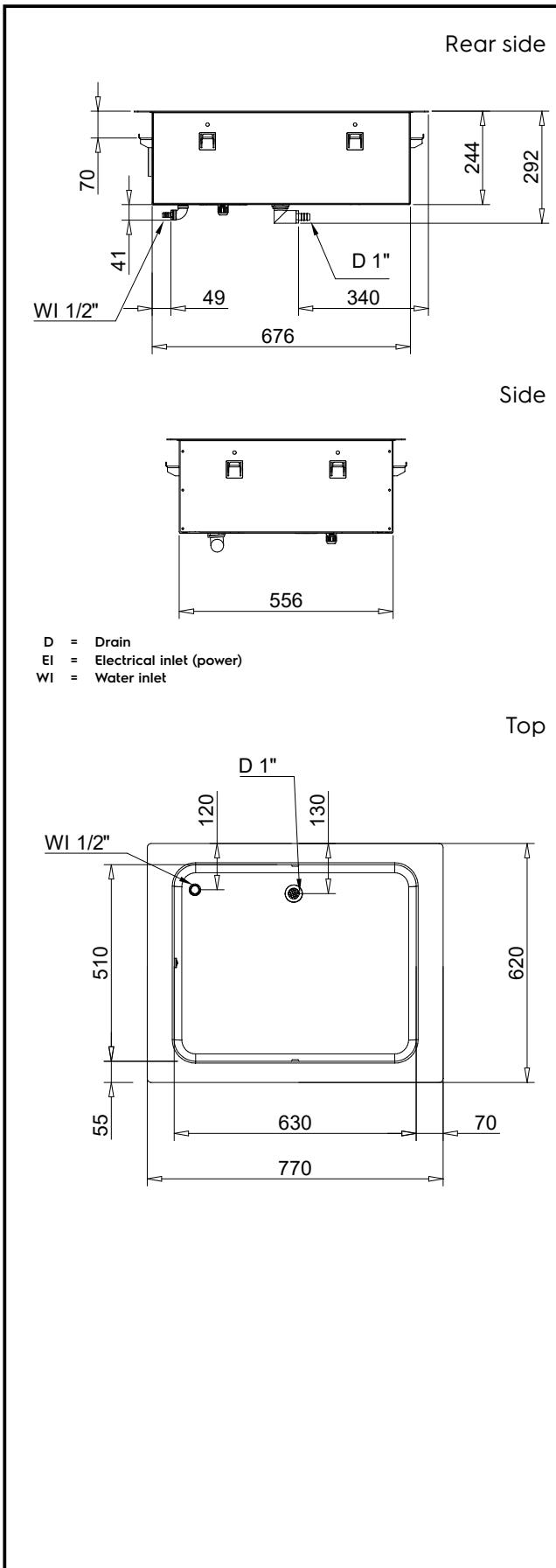

### Electric

Supply voltage:

341000 (D01H2) 220-240 V/1N ph/50/60 Hz

Electrical power max.:

2.02 kW

### Water:

Water inlet "CW" connection: 1/2"

Drain line size: 1"

### Key Information:

External dimensions, Width: 770 mm

External dimensions, Depth: 620 mm

External dimensions, Height: 260 mm

Net weight: 21.4 kg

Shipping weight: 42 kg

Shipping height: 380 mm

Shipping width: 660 mm

Shipping depth: 810 mm

Shipping volume: 0.2 m<sup>3</sup>

Set temperature: +85 / +95 °C

### Sustainability

Noise level: 0 dBA



CAPACITY	CUTOUT		LOWERING FOR FLUSH INSTALLATION		C
	A1	B1	A2	B2	
2GN	700	580	774	624	880
3GN	1030		1104		1200
4GN	1350	580	1424	624	1530
5GN	1670		1744		1850
6GN	2000		2074		2180



**595T01N00 - WATER BAIN MARIE SINGLE WELL**